



Stripecoil

The passable smoke barrier, but still ground-closing

Product Description

textile smoke curtain

The passable and floor-closing smoke curtain Stripecoil is the optimum smoke protection for personal passage areas and in escape routes - designed for the temperature classes D = 600 0C (for 120 min) and DH (ETK curve, for 30 min). Even at a width of 3 m, the passage will allow around 200 persons (even with strollers and wheelchairs) to pass per minute. The translucent fabric of the curtain ensures optimum light and visions conditions in passage areas. A soft and yielding closing edge also helps to minimise the risk of injury. The smoke curtain closes without any external energy with a 'Gravigen' drive motor.

construction type	textile smoke curtain	closing cycle	1,000 cycles acc. to DIN EN 12101-1
certificate for the usability	CE acc. to DIN EN 12101-1	classifications	DH 30 • D 120 • classifications according to DIN EN 12101-1
fabric	Modutex 600 A2	Triggering for	authorized hold open device • provided by site
closing direction	from top to bottom		
proof	Z - 56. 429 - 916 • 0761-CPD-0060		

Constructive structure (Two winding shafts)

fabric	system width	drop length	t	h
Modutex 600 A2	> 1,4 m - ≤ 2,7 m	≤ 3,5 m	330 mm	270 mm
Modutex 600 A2	> 2,7 m - ≤ 15 m	≤ 3,5 m	330 mm	200 mm

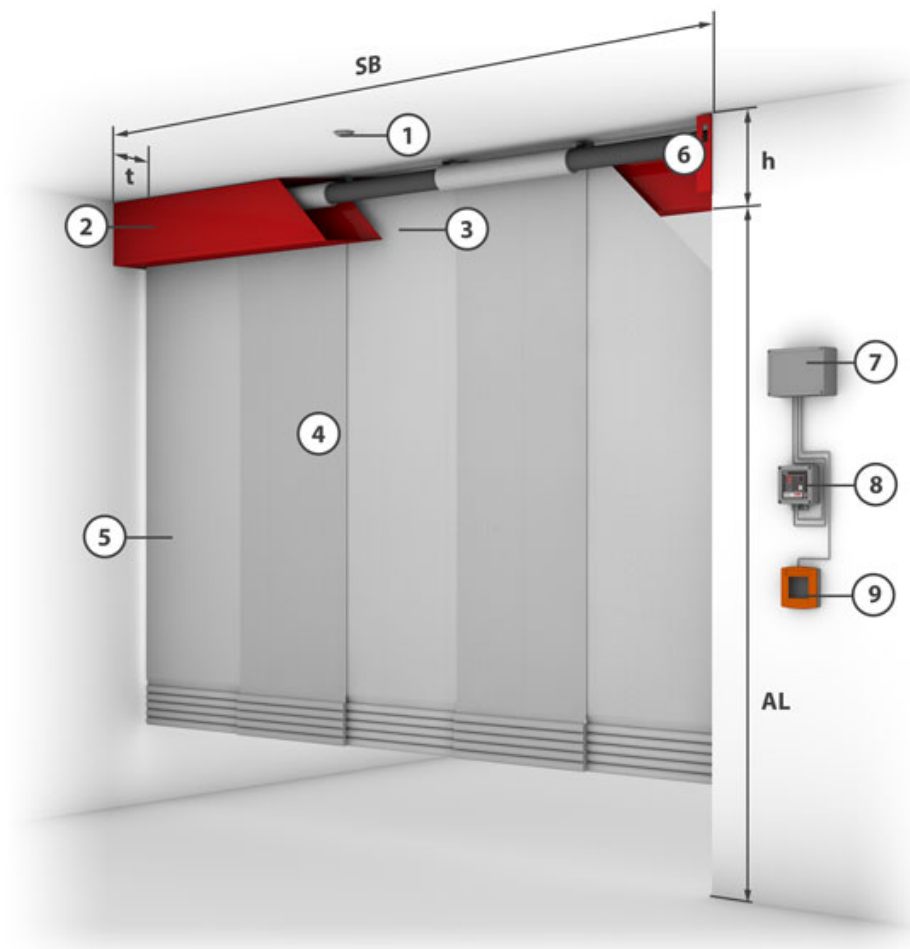

- 1** = Smoke detector **2** = Casing **3** = Side guide **4** = Fixing bracket **5** = Fabric **6** = Closing element **7** = Tubular motor
8 = Control module **9** = Control with operating unit **10** = Manual release

Constructive structure (One winding shaft)

fabric	system width	drop length	t	h
Modutex 600 A2	> 1 m - ≤ 1,8 m	≤ 3,5 m	190 mm	290 mm
Modutex 600 A2	> 1,8 m - ≤ 6 m	≤ 3,5 m	190 mm	225 mm

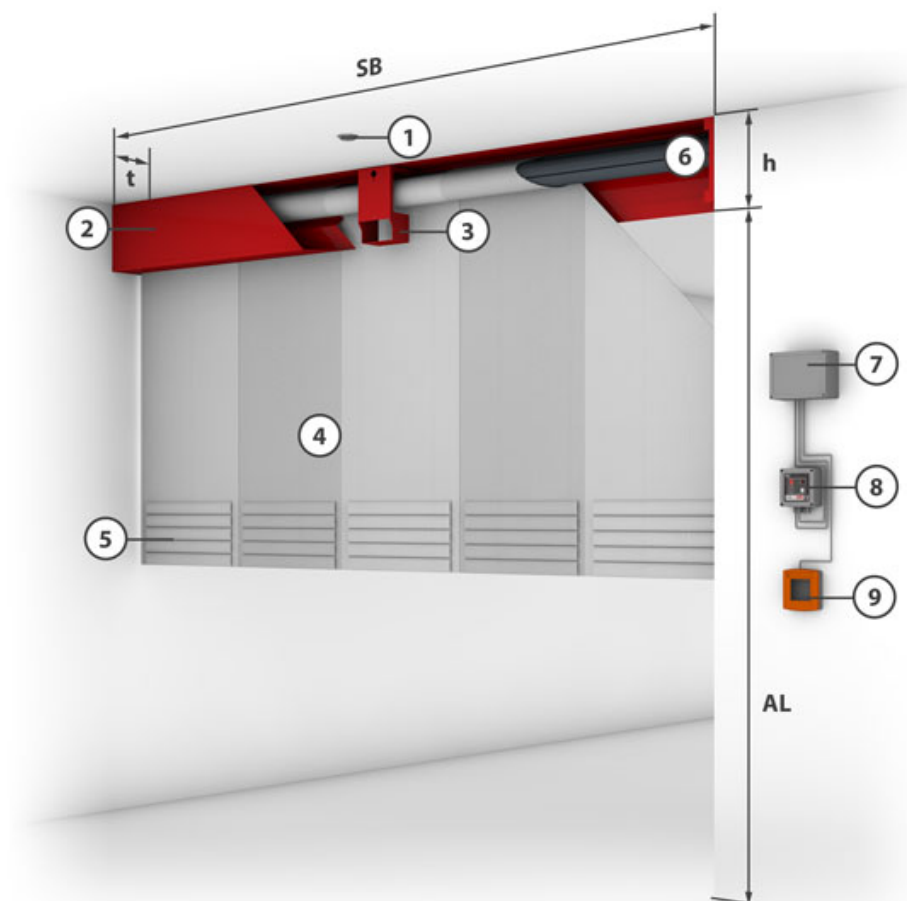

- 1** = Smoke detector **2** = Casing **3** = Side guide **4** = Fixing bracket **5** = Fabric **6** = Closing element **7** = Tubular motor
8 = Control module **9** = Control with operating unit **10** = Manual release

bottom bar

flexible bottom bar

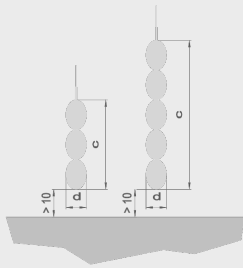

alternatives for installation

Attached to the ceiling

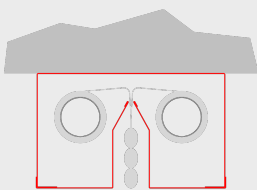

Attached to the wall

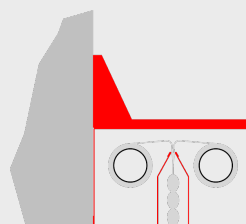

housing

Multi-coil, to the wall

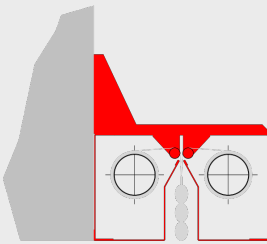

Multi-coil, to the wall (270)

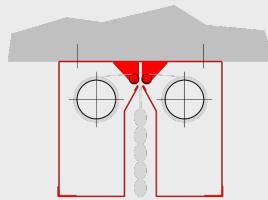

SB = $\leq 2,7$ m

Multi-coil, to the wall (200)

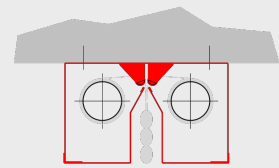

SB = $> 2,7$ m

Single coil for wall mounting

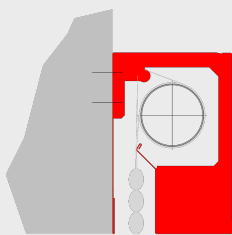

Single coil for ceiling mounting

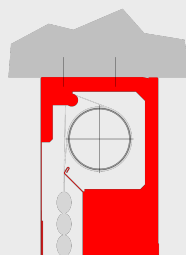

side guides

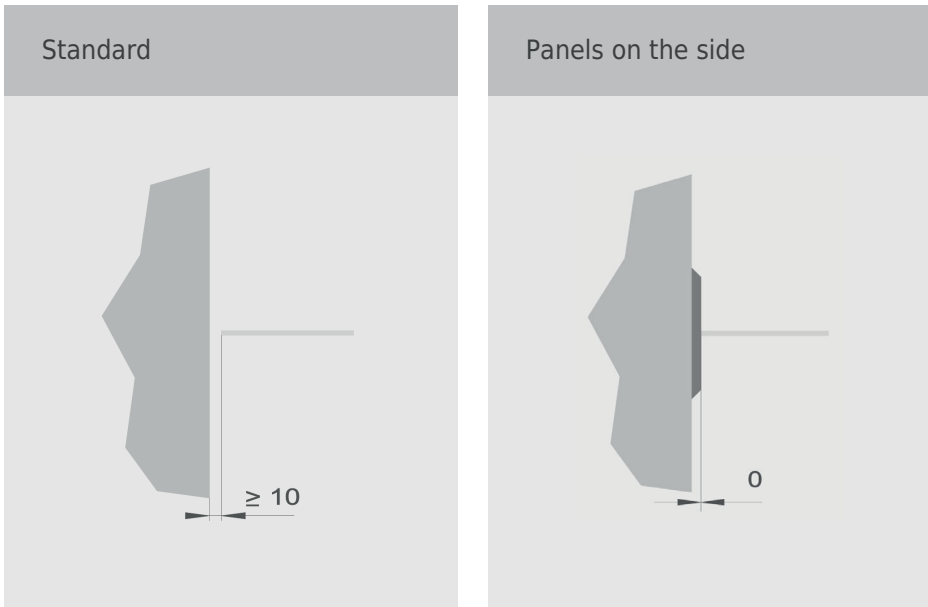

references

Fashion house, Bertrange Luxemburg



Har du brug for yderligere oplysninger eller ønsker et konkret tilbud, så kontakt os gerne på telefon 86 92 11 71 eller send en e-mail på info@doorsystem.dk.

DOORSYSTEM

Agerskovvej 16 · DK-8362 Hørning · Denmark · www.doorsystem.dk